

The multi-talented one: S 3000 *Evolo*

NEW



The Evolo ventilation concept:

It ensures effective ventilation and drying of clothing with steel doors. Thanks to its air flow behavior, it works without additional ventilation equipment. Uniform ventilation of the entire interior is guaranteed even in lockers with bases (see graphic)!

The air inlet in the rear bottom of the locker ensures sufficient ventilation and drying in the compartment (see graphic). In lockers with bases, ventilation is ensured via openings above the recessed base.



Increased anti-burglary protection thanks to extremely warp resistant doors! This is ensured by closed profiles on the sides. The doorstop silencers are a standard feature.



New door opening limiter 90°: Made from special heavy-duty, plastic-coated stainless steel cable.



Custom-made for specific applications.



Ergonomically designed turning bolt latch: With door protection (standard) for lock bolt size 6-8 mm.



Feet made of plastic for optimum corrosion protection: They consistently underpin the linear design and have a protective sleeve that covers the adjusting screw when the optional height adjustment is used. An ingenious feature!

Lockers



Lockers 404



Multi-purpose lockers 414



Double-tier lockers 416



Assembled box lockers 420



Open wardrobes 424



Optional integration of numbering: With self-adhesive film in the embossed label holder (optional).



Exchangeable fronts: (can also be retrofitted!) Choice of steel or decor doors (MDF or HPL). Door opening limiters are a standard feature with decor doors.



Double coat hooks For ease of operation, with integrated space for coat hangers.



Easy-to-clean ventilation hole pattern: Thanks to the smooth outer front (no protruding louvers).

S 3000 *Evolo* **NEW**

The S 3000 Evolo series offers:

- Increased anti-burglary protection thanks to extremely warp-resistant doors and a 54° slope on the body interior – for high stability and an easy, convenient way to remove clothing
- Durable steel structure
- 2 compartment widths, 5 different box heights
- Sub-frame alternatively with feet, base, storage box, or bench
- Ventilation ensured by EVL (Evolu Ventilation Concept)
- Doors hinged right, borne on hinge pins, with easy-to-clean hole pattern and embossed label holder for optional integration of numbering
- Convenient doorstop silencers for pleasant closing behavior



Sub-frame with feet



Sub-frame with base

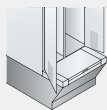

Sub-frame with box



Sub-frame with bench



Steel fronts



Wood decor fronts (MDF)



EVL self-ventilation



Lockers with feet

on feet 150 mm high, depth 500 mm.
Clear opening dimensions per door:
1600 x 230/330 x 465 mm (H x W x D)



1. Dimensions and door material

Steel doors



Width	300	400	600	800	900	1200
Height	1850	1850	1850	1850	1850	1850
Compartments	1 x 300	1 x 400	2 x 300	2 x 400	3 x 300	3 x 400
CSC	2	3	4	5	5	6
Order no.	49010-10	49010-12	49010-20	49010-22	49010-30	49010-32
Price €	226,-	274,-	299,-	399,-	429,-	568,-

Lockers with base

on base 100 mm high, depth 500 mm.
Clear opening dimensions per door:
1600 x 230/330 x 465 mm (H x W x D)



1. Dimensions and door material

Steel doors



Width	300	400	600	800	900	1200
Height	1800	1800	1800	1800	1800	1800
Compartments	1 x 300	1 x 400	2 x 300	2 x 400	3 x 300	3 x 400
CSC	2	3	4	5	5	6
Order no.	49020-10	49020-12	49020-20	49020-22	49020-30	49020-32
Price €	238,-	288,-	315,-	417,-	447,-	590,-

+ MDF decor doors



Thickness 18 mm						
+ Order no.	+ 49110-750	+ 49112-750	+ 49120-750	+ 49122-750	+ 49130-750	+ 49132-750
+ Addtl. charge €	+ 40,-	+ 50,-	+ 80,-	+ 100,-	+ 120,-	+ 150,-

+ HPL decor doors



Thickness 13 mm						
+ Order no.	+ 49110-730	+ 49112-730	+ 49120-730	+ 49122-730	+ 49130-730	+ 49132-730
+ Addtl. charge €	+ 60,-	+ 80,-	+ 120,-	+ 160,-	+ 180,-	+ 240,-

2. Body color (see end of catalog for color overview)

Please choose **587**

3. Door color (door decor for MDF or HPL design if applicable)

Please choose **587**

Lockers



- Decor doors (MDF and HPL) as standard with door opening limiter 90° made from special heavy-duty, plastic-coated stainless steel cable
- HPL decor doors available in white, silver gray, birch, cherry, and wenge
- Exchangeable front concept with steel or MDF decor doors, can also be retrofitted
- Interior is easy to clean because compartment shelves can be swept out smoothly (models 48030/48040 with cleaning openings)
- Hat shelf with rear anti-roll support and sturdy wardrobe rod made of oval profile, 3 twist-proof hooks with system holder, e.g. for coat hangers or movable partitions
- Ergonomic safety turning bolt latch for padlock with lock guard as practical basic fitting
- **Locker feet (e.g. in models 49010) made of plastic = improved corrosion protection!**
- Feet in light gray with body color RAL 7035, in black with all other body colors
- **Slot-in shoe shelf, can be easily retrofitted by users**
- **Optimal air circulation via predefined ventilation spaces in front of and behind the hat shelf**



1.	1200	1600	1500
	1850	1850	1850
	4 x 300	4 x 400	5 x 300
	6	8	8
	49010-40	49010-42	49010-50
	571,-	749,-	719,-



1.	1200	1600	1500
	1800	1800	1800
	4 x 300	4 x 400	5 x 300
	6	8	8
	49020-40	49020-42	49020-50
	593,-	773,-	743,-

+			
	+ 49140-750	+ 49142-750	+ 49150-750
	+ 160,-	+ 200,-	+ 200,-

+			
	+ 49140-730	+ 49142-730	+ 49150-730
	+ 240,-	+ 320,-	+ 300,-

+	Accessories	
	Additional fittings, locks	429 - 435



Order no. 49010-20 (with feet)

Optional: **Decor fronts** (MDF)
You can choose from the following
decors (surface "Supermatt"):



Birch



Cherry



Wenge

Lockers with bench

Bench slats for models 49030, 49040, and 49050 made of beech as standard design, approx. 60 x 35 mm side-face, planed on all sides, rounded at the top, finished with clear varnish, with natural color differences. Plastic bench slats are available at no additional charge. Standard color of the bench underframes: black gray RAL 7021. Benches with adjustable floor gliders for easy level adjustment (10 mm). Locker and bench are delivered separately for easy DIY assembly.

Bench height: 420 mm
Bench depth: 315 mm
Locker depth: 500/815 mm

Lockers with bench in front

on feet 150 mm high, with doors reduced in size, depth 500 mm. Clear opening dimensions per door: 1315 x 230/330 x 465 mm (H x W x D)

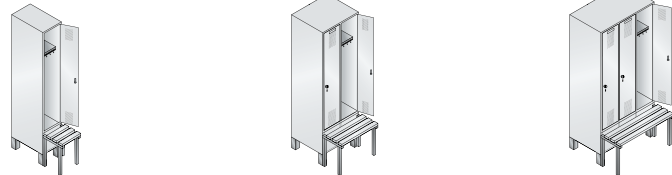

1. Dimensions and door material	Width	300	400	600	800	900	1200
	Height	1850	1850	1850	1850	1850	1850
	Compartments	1 x 300	1 x 400	2 x 300	2 x 400	3 x 300	3 x 400
	CSC	2	3	4	5	5	6
	Order no.	49030-10	49030-12	49030-20	49030-22	49030-30	49030-32
	Price €	349,-	399,-	491,-	611,-	635,-	791,-

Lockers with lowered bench underframe

with doors reduced in size, depth 500 mm. Clear opening dimensions per door: 1315 x 230/330 x 465 mm (H x W x D)



1. Dimensions and door material	Width	300	400	600	800	900	1200
	Height	1850	1850	1850	1850	1850	1850
	Compartments	1 x 300	1 x 400	2 x 300	2 x 400	3 x 300	3 x 400
	CSC	2	3	4	5	5	6
	Order no.	49040-10	49040-12	49040-20	49040-22	49040-30	49040-32
	Price €	379,-	439,-	545,-	663,-	713,-	868,-

Lockers with bench underneath

Clear opening dimensions per door: 1600 x 230/330 x 465 mm (H x W x D)



1. Dimensions and door material	Width	300	400	600	800	900	1200
	Height	2090	2090	2090	2090	2090	2090
	Compartments	1 x 300	1 x 400	2 x 300	2 x 400	3 x 300	3 x 400
	CSC	2	3	4	5	5	6
	Order no.	49050-10	49050-12	49050-20	49050-22	49050-30	49050-32
	Price €	359,-	419,-	505,-	623,-	653,-	808,-

+	MDF decor doors	Thickness 18 mm						
	+ Order no.		+ 49110-750	+ 49112-750	+ 49120-750	+ 49122-750	+ 49130-750	+ 49132-750
	+ Addtl. charge €		+ 40,-	+ 50,-	+ 80,-	+ 100,-	+ 120,-	+ 150,-

+	HPL decor doors	Thickness 13 mm						
	+ Order no.		+ 49110-730	+ 49112-730	+ 49120-730	+ 49122-730	+ 49130-730	+ 49132-730
	+ Addtl. charge €		+ 60,-	+ 80,-	+ 120,-	+ 160,-	+ 180,-	+ 240,-

2. Body color	(see end of catalog for color overview)
	Please choose 587

3. Door color	(door decor for MDF or HPL design if applicable)
	Please choose 587

+ Bench slats made of plastic	Light gray	White	Dark gray	Black gray
+ Order no.	+ 8000-7035	+ 8000-9010	+ 8000-7031	+ 8000-7021
+ Addtl. charge €	+ 0,-	+ 0,-	+ 0,-	+ 0,-

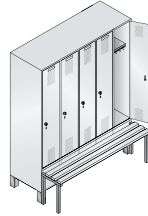
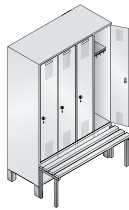

1.	1200	1600	1500
	1850	1850	1850
	4 x 300	4 x 400	5 x 300
	6	8	8
	49030-40	49030-42	49030-50
	791,-	983,-	969,-

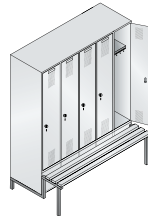
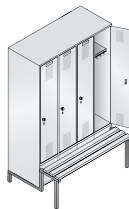

1.	1200	1600	1500
	1850	1850	1850
	4 x 300	4 x 400	5 x 300
	6	8	8
	49040-40	49040-42	49040-50
	895,-	1.099,-	1.079,-

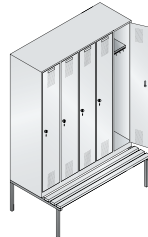

1.	1200	1600	1500
	2090	2090	2090
	4 x 300	4 x 400	5 x 300
	6	8	8
	49050-40	49050-42	49050-50
	815,-	1.019,-	999,-

+	+ 49140-750	+ 49142-750	+ 49150-750
	+ 160,-	+ 200,-	+ 200,-

+	+ 49140-730	+ 49142-730	+ 49150-730
	+ 240,-	+ 320,-	+ 300,-

+ Accessories	
Additional fittings, locks	429 - 435



Order no. 49030-30
+ 49130-750 (MDF decor doors)
+ 0008-70 (cylinder lock)



Order no. 49040-40



Order no. 49050-40
+ 8050-7010 (shoe rack)

+ Shoe rack	
for models 49050	430

S 3000 *Erolo* **NEW**

Lockers with pairs of doors closing in the middle

For joint lock of two compartments to be used by one person, for example for storing **street clothes and work clothing**, hat shelf across 2 compartments. Bench slats for models 49032 and 49042 made of beech as standard design, approx. 60 x 35 mm side-face, planed on all sides, rounded at the top, finished with clear varnish, with natural color differences. Bench slats made of plastic in white, light gray, dark gray, or black gray available for no additional charge. Standard color for bench bases: Black gray RAL 7021. Benches with adjustable floor gliders for easy level adjustment (10 mm). All doors with turning bolt latch for padlock use. Locker and bench are delivered separately for easy DIY assembly.

For general description of the lockers see page 404/405.

Lockers with benches

Bench height: 420 mm

Bench depth: 315 mm

Locker depth: 500/815 mm



Order no. 49022-20

Lockers with feet

on feet 150 mm high, depth 500 mm.
Clear opening dimensions per door:
1600 x 230/330 x 465 mm (H x W x D)

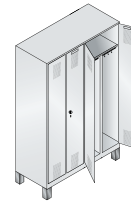

1. Dimensions and door material



	600	800	1200	1600
Width	600	800	1200	1600
Height	1850	1850	1850	1850
Compartments	2 x 300	2 x 400	4 x 300	4 x 400
for no. of persons	1	1	2	2
CSC	4	5	6	8
Order no.	49012-20	49012-22	49012-40	49012-42
Price €	299,-	399,-	571,-	749,-

Lockers with base

on base 100 mm high, depth 500 mm.
Clear opening dimensions per door:
1600 x 230/330 x 465 mm (H x W x D)



1. Dimensions and door material



	600	800	1200	1600
Width	600	800	1200	1600
Height	1800	1800	1800	1800
Compartments	2 x 300	2 x 400	4 x 300	4 x 400
for no. of persons	1	1	2	2
CSC	4	5	6	8
Order no.	49022-20	49022-22	49022-40	49022-42
Price €	315,-	417,-	593,-	773,-

+ MDF decor doors



Thickness 18 mm				
+ Order no.	+ 49120-750	+ 49122-750	+ 49140-750	+ 49142-750
+ Addtl. charge €	+ 80,-	+ 100,-	+ 160,-	+ 200,-

+ HPL decor doors



Thickness 13 mm				
+ Order no.	+ 49120-730	+ 49122-730	+ 49140-730	+ 49142-730
+ Addtl. charge €	+ 120,-	+ 160,-	+ 240,-	+ 320,-

2. Body color (see end of catalog for color overview)

Please choose **587**

3. Door color (door decor for MDF or HPL design if applicable)

Please choose **587**



Order no. 49042-40

+ Bench slats made of plastic

	Light gray	White	Dark gray	Black gray
+ Order no.	+ 8000-7035	+ 8000-9010	+ 8000-7031	+ 8000-7021
+ Addtl. charge €	+ 0,-	+ 0,-	+ 0,-	+ 0,-

Lockers with bench in front

on feet 150 mm high, with doors reduced in size, depth 500 mm.
Clear opening dimensions per door:
1315 x 230/330 x 465 (H x W x D)

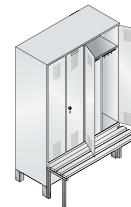

1. Dimensions and door material

	600	800	1200	1600
Width	600	800	1200	1600
Height	1850	1850	1850	1850
Compartments	2 x 300	2 x 400	4 x 300	4 x 400
for no. of persons	1	1	2	2
Steel doors				
CSC	4	5	6	8
Order no.	49032-20	49032-22	49032-40	49032-42
Price €	491,-	611,-	791,-	983,-

Steel doors



Lockers with lowered bench underframe

with doors reduced in size, depth 500 mm.
Clear opening dimensions per door:
1315 x 230/330 x 465 (H x W x D)



1. Dimensions and door material

	600	800	1200	1600
Width	600	800	1200	1600
Height	1850	1850	1850	1850
Compartments	2 x 300	2 x 400	4 x 300	4 x 400
for no. of persons	1	1	2	2
Steel doors				
CSC	4	5	6	8
Order no.	49042-20	49042-22	49042-40	49042-42
Price €	545,-	663,-	895,-	1.099,-

Steel doors



+ MDF decor doors



Thickness 18 mm				
+ Order no.	+ 49120-750	+ 49122-750	+ 49140-750	+ 49142-750
+ Addtl. charge €	+ 80,-	+ 100,-	+ 160,-	+ 200,-

+ HPL decor doors



Thickness 13 mm				
+ Order no.	+ 49120-730	+ 49122-730	+ 49140-730	+ 49142-730
+ Addtl. charge €	+ 120,-	+ 160,-	+ 240,-	+ 320,-

+ Accessories

Additional fittings, locks **429** - **435**

Lockers with pairs of doors closing in the middle

For joint lock of two compartments to be used by one person, for example for storing **street clothes and work clothing**, hat shelf across 2 compartments. Bench slats for models 49052 made of beech as standard design, approx. 60 x 35 mm side-face, planed on all sides, rounded at the top, finished with clear varnish, with natural color differences. Bench slats made of plastic in white, light gray, dark gray, or black gray available for no additional charge (standard color light gray). Standard color of the bench bases: Black gray RAL 7021. Benches and box with adjustable floor gliders for easy level adjustment (10 mm). All doors with turning bolt latch for padlock use. Locker and bench are delivered separately for easy DIY assembly.

For general description of the lockers see page 404/405.

Models 49052

Bench height: 420 mm

Bench depth: 315 mm

Locker depth: 500/815 mm

Models 49056

Bench height: 452 mm

Bench depth: 315 mm

Locker depth: 500/815 mm



Order no. 49052-40
+ 8000-7035 (with plastic bench slats)

Lockers with bench underneath

on feet 150 mm high, depth 500 mm.
Clear opening dimensions per door:
1600 x 230/330 x 465 mm (H x W x D)



1. Dimensions and door material



	600	800	1200	1600
Width	600	800	1200	1600
Height	2090	2090	2090	2090
Compartments	2 x 300	2 x 400	4 x 300	4 x 400
for no. of persons	1	1	2	2
CSC	4	5	6	8
Order no.	49052-20	49052-22	49052-40	49052-42
Price €	505,-	623,-	815,-	1.019,-

Lockers with storage box underneath

Depth 500 mm. Clear opening dimensions per door:
1600 x 230/330 x 465 mm (H x W x D)



1. Dimensions and door material



	600	800	1200	1600
Width	600	800	1200	1600
Height	2090	2090	2090	2090
Compartments	2 x 300	2 x 400	4 x 300	4 x 400
for no. of persons	1	1	2	2
CSC	4	5	6	8
Order no.	49056-20	49056-22	49056-40	49056-42
Price €	669,-	789,-	1.079,-	1.295,-



Thickness 18 mm				
+ Order no.	+ 49120-750	+ 49122-750	+ 49140-750	+ 49142-750
+ Addtl. charge €	+ 80,-	+ 100,-	+ 160,-	+ 200,-



Thickness 13 mm				
+ Order no.	+ 49120-730	+ 49122-730	+ 49140-730	+ 49142-730
+ Addtl. charge €	+ 120,-	+ 160,-	+ 240,-	+ 320,-



Practical storage box for shoes, helmets, bags, etc. This allows the storage space under the seat to be used optimally - not to mention easy cleaning!



The seat made of solid beech wood also serves as a flap and can be opened only by the owner of the locker.

2. Body color (see end of catalog for color overview)
 Please choose **587**

3. Door color (door decor for MDF or HPL design if applicable)
 Please choose **587**

+ Accessories
 Additional fittings, locks **429** - **435**

+ Shoe rack for models 48052 **430**



Order no. 49056-40

Lockers with one door over two compartments

for storing **street clothes and work clothing**. Bench slats for models 49250 made of beech as standard design, approx. 60 x 35 mm side-face, planed on all sides, rounded at the top, finished with clear varnish, with natural color differences. Bench slats made of plastic in white, light gray, dark gray, or black gray available for no additional charge (standard color light gray). Standard color of the bench bases: Black gray RAL 7021. Benches with adjustable floor gliders for easy level adjustment (10 mm). One door with turning bolt latch locks two compartments at the same time. Hat shelf, coat rail, and 3 sliding hooks to the left and right of the inner partition. Locker and bench are delivered separately for easy DIY assembly.

For general description of the lockers see page 404/405.

Lockers with benches
Bench height: 420 mm
Bench depth: 315 mm
Locker depth: 500/815 mm

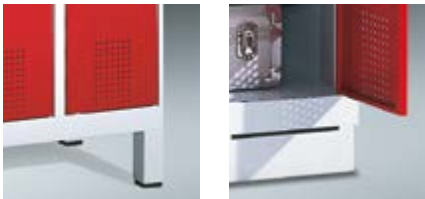

Order no. 49210-40

Lockers with feet

on feet 150 mm high, depth 500 mm.
 Clear opening dimensions per door:
 1600 x 230/330 x 465 mm (H x W x D)

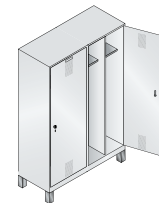
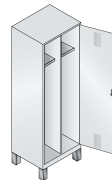

1. Dimensions and door material



	600	1200
Width	600	1200
Height	1850	1850
Compartments	2 x 300	4 x 300
for no. of persons	1	2
CSC	4	6
Order no.	49210-20	49210-40
Price €	299,-	571,-

2. Body and door color



Please select (see end of catalog for color overview) **587**



Lockers with base

on base 100 mm high, depth 500 mm.
Clear opening dimensions per door:
1600 x 230/330 x 465 mm (H x W x D)

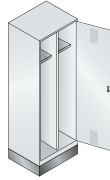

1. Dimensions and door material

	600	1200
Width	600	1200
Height	1800	1800
Compartments	2 x 300	4 x 300
for no. of persons	1	2
CSC	4	6
Order no.	49220-20	49220-40
Price €	315,-	593,-

Steel doors



Lockers with bench underneath

Depth 500 mm.
Clear opening dimensions per door:
1600 x 230/330 x 465 mm (H x W x D)

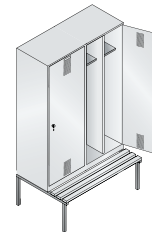

1. Dimensions and door material

	600	1200
Width	600	1200
Height	2090	2090
Compartments	2 x 300	4 x 300
for no. of persons	1	2
CSC	4	6
Order no.	49250-20	49250-40
Price €	505,-	815,-

Steel doors



+ Bench slats made of plastic	Light gray	White	Dark gray	Black gray
	+ Order no.	+ 8000-7035	+ 8000-9010	+ 8000-7031
+ Addtl. charge €	+ 0,-	+ 0,-	+ 0,-	+ 0,-

+ Accessories	
Additional fittings, locks	429 - 435

+ Shoe rack	
for models 48250	430



Order no. 49250-40
(with plastic bench slats)



CSC = color surcharge code number

Laundry lockers and cleaning cabinets

Doors closing in the middle with a joint turning bolt latch for padlock, shelves not height adjustable.
For general description of the lockers see page 404/405.



Order no. 49160-20

Order no. 49120-00

Order no. 49222-20B

Lockers with feet

on feet 150 mm high, depth 500 mm

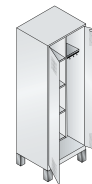

1. Dimensions and door material

	600	800	600	800
Width	600	800	600	800
Height	1850	1850	1850	1850
Compartments	2 x 300	2 x 400	2 x 300	2 x 400
Description	Laundry lockers 4 shelves on the left, hat shelf with coat rail and 3 sliding hooks on the right		Cleaning equipment cabinet 4 compartments to the left of the shortened partition, rail with 6 sliding hooks on the right	



CSC	4	5	4	5
Order no.	49060-20	49060-22	49110-00	49110-02
Price €	379,-	489,-	389,-	511,-

Lockers with base

on base 100 mm high, depth 500 mm



1. Dimensions and door material

	600	800	600	800
Width	600	800	600	800
Height	1800	1800	1800	1800
Compartments	2 x 300	2 x 400	2 x 300	2 x 400
Description	see above		see above	



CSC	4	5	4	5
Order no.	49160-20	49160-22	49120-00	49120-02
Price €	395,-	507,-	405,-	529,-

2. Body color (see end of catalog for color overview)

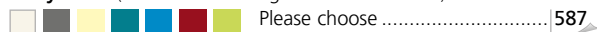

3. Door color (door decor for MDF or HPL design if applicable)

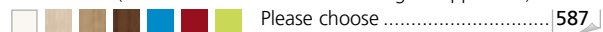

+ **Accessories**

Additional fittings, locks **429** - **435**

Multi-purpose lockers

Laundry and storage lockers

Doors with turning bolt latch, shelves not height adjustable.

For general description of the lockers see page 404/405.

- + Doors smooth**
for all S 3000 Evolo locker models without louvers, without label holder, very easy to clean



Design	smooth
+ Order no.	+ 8001-303
+ Addtl. charge €	+ 0,-



Order no. 49020-20B



Order no. 49022-20B

Lockers with feet

on feet 150 mm high, depth 500 mm



1. Dimensions and door material

	600	800	600	800	600
Width	600	800	600	800	600
Height	1850	1850	1850	1850	1850
Compartments	2 x 300	2 x 400	2 x 300	2 x 400	1 x 600
Description	with individually lockable doors (both hinged right)		with doors closing in the middle (joint lock)		with doors closing in the middle without partition, 4 full-width shelves



Steel doors	CSC	4	5	4	5	4
	Order no.	49010-20B	49010-22B	49012-20B	49012-22B	49212-20B
	Price €	433,-	549,-	433,-	549,-	399,-

Lockers with base

on base 100 mm high, depth 500 mm

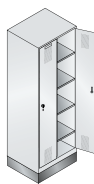

1. Dimensions and door material

	600	800	600	800	600
Width	600	800	600	800	600
Height	1800	1800	1800	1800	1800
Compartments	2 x 300	2 x 400	2 x 300	2 x 400	1 x 600
Description	see above		see above		see above



Steel doors	CSC	4	5	4	5	4
	Order no.	49020-20B	49020-22B	49022-20B	49022-22B	49222-20B
	Price €	449,-	567,-	449,-	567,-	415,-



MDF decor doors	Thickness 18 mm					
	+ Order no.	+ 49120-750	+ 49122-750	+ 49120-750	+ 49122-750	-
	+ Addtl. charge €	+ 80,-	+ 100,-	+ 80,-	+ 100,-	-



HPL decor doors	Thickness 13 mm					
	+ Order no.	+ 49120-730	+ 49122-730	+ 49120-730	+ 49122-730	-
	+ Addtl. charge €	+ 120,-	+ 160,-	+ 120,-	+ 160,-	-



Lockers with feet

on feet 150 mm high, depth 500 mm.
Clear opening dimensions per door:
813 x 230/330 x 465 mm (H x W x D)



1. Dimensions and door material

	600	800	900	1200	1200	1600
Width	600	800	900	1200	1200	1600
Height	1850	1850	1850	1850	1850	1850
Compartments	2 x 300	2 x 400	3 x 300	3 x 400	4 x 300	4 x 400
 Steel doors	CSC	CSC	CSC	CSC	CSC	CSC
	4	5	5	6	6	8
	Order no. 49310-20	49310-22	49310-30	49310-32	49310-40	49310-42
	Price € 399,-	499,-	539,-	679,-	719,-	899,-

+



MDF decor doors

Thickness 18 mm

+ Order no.	+ 49220-750	+ 49222-750	+ 49230-750	+ 49232-750	+ 49240-750	+ 49242-750
+ Addtl. charge €	+ 120,-	+ 140,-	+ 180,-	+ 210,-	+ 240,-	+ 280,-

+



HPL decor doors

Thickness 13 mm

+ Order no.	+ 49220-730	+ 49222-730	+ 49230-730	+ 49232-730	+ 49240-730	+ 49242-730
+ Addtl. charge €	+ 160,-	+ 200,-	+ 240,-	+ 300,-	+ 320,-	+ 400,-

2. Body color (see end of catalog for color overview)

 Please choose 587

3. Door color (door decor for MDF or HPL design if applicable)

 Please choose 587

Double-tier lockers

NEW

Double-tier lockers with turning bolt latch

Lockers, double-tier, 2 compartments on top of one another, 1 door, coat rail, and 3 sliding hooks per compartment, doors with turning bolt latch for padlock, decor doors with door opening limiter as a standard fitting.
For general description of the lockers see page 404/405.



Order no. 49320-30
+ 49230-750 (MDF decor doors)





Order no. 49310-40

Lockers with base

on base 100 mm high, depth 500 mm.
Clear opening dimensions per door:
813 x 230/330 x 465 mm (H x W x D)



1. Dimensions and door material	Width	600	800	900	1200	1200	1600	
	Height	1800	1800	1800	1800	1800	1800	
	Compartments	2 x 300	2 x 400	3 x 300	3 x 400	4 x 300	4 x 400	
	Steel doors	CSC	4	5	5	6	6	8
	Order no.	49320-20	49320-22	49320-30	49320-32	49320-40	49320-42	
	Price €	415,-	517,-	557,-	699,-	741,-	923,-	

	MDF decor doors	Thickness 18 mm						
	+ Order no.		+ 49220-750	+ 49222-750	+ 49230-750	+ 49232-750	+ 49240-750	+ 49242-750
	+ Addtl. charge €		+ 120,-	+ 140,-	+ 180,-	+ 210,-	+ 240,-	+ 280,-

	HPL decor doors	Thickness 13 mm						
	+ Order no.		+ 49220-730	+ 49222-730	+ 49230-730	+ 49232-730	+ 49240-730	+ 49242-730
	+ Addtl. charge €		+ 160,-	+ 200,-	+ 240,-	+ 300,-	+ 320,-	+ 400,-

+ Accessories
Additional fittings, locks **429** | - **435**

CSC = color surcharge code number

Double-tier lockers with turning bolt latches

Lockers, double-tier, 2 compartments on top of one another, 1 door, coat rail, and 3 sliding hooks per compartment, doors with turning bolt latch for padlock. Bench slats for models 49350 made of beech as standard design, approx. 60 x 35 mm side-face, planed on all sides, rounded at the top, finished with clear varnish, with natural color differences. Bench slats made of plastic in white, light gray, dark gray, or black gray available for no additional charge (standard color light gray). Standard color of the bench bases: Black gray RAL 7021. Benches with adjustable floor gliders for easy level adjustment (10 mm).

Locker and bench are delivered separately for easy DIY assembly.

For general description of the lockers see page 404/405.



The C+P safety turning bolt cannot be overwound because it "spins" when it is closed, thus preventing tampering!

The cylinder lock engages only when the padlock is removed, and the door can be opened simply by turning the knob. For bolt lock size 6-8 mm.

Standard in all Evolo lockers!





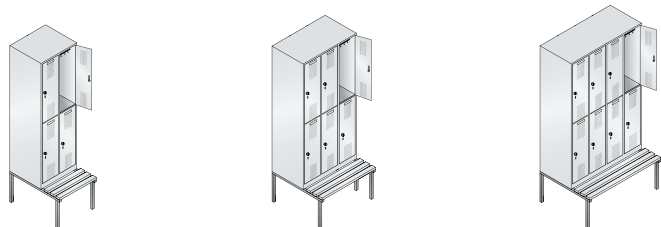

Order no. 49350-30

Lockers with bench underneath

Bench height 420 mm, bench depth 315 mm, locker depth 500/815 mm. Clear opening dimensions per door: 813 x 230/330 x 465 mm (H x W x D)

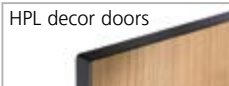

1. Dimensions and door material	Width	600	800	900	1200	1200	1600
	Height	2090	2090	2090	2090	2090	2090
	Compartments	2 x 300	2 x 400	3 x 300	3 x 400	4 x 300	4 x 400
 Steel doors	CSC	4	5	5	6	6	8
	Order no.	49350-20	49350-22	49350-30	49350-32	49350-40	49350-42
	Price €	599,-	719,-	759,-	919,-	959,-	1.149,-
 + MDF decor doors	Thickness 18 mm						
	+ Order no.	+ 49220-750	+ 49222-750	+ 49230-750	+ 49232-750	+ 49240-750	+ 49242-750
	+ Addtl. charge €	+ 120,-	+ 140,-	+ 180,-	+ 210,-	+ 240,-	+ 280,-
 + HPL decor doors	Thickness 13 mm						
	+ Order no.	+ 49220-730	+ 49222-730	+ 49230-730	+ 49232-730	+ 49240-730	+ 49242-730
	+ Addtl. charge €	+ 160,-	+ 200,-	+ 240,-	+ 300,-	+ 320,-	+ 400,-

2. **Body color** (see end of catalog for color overview)
 Please choose **587**

3. **Door color** (door decor for MDF or HPL design if applicable)
 Please choose **587**

+ **Shoe rack**
 for models 48350 **430**

Combination lockers with turning bolt latches

Models 49600 with turning bolt latches, compartment width 400 mm. The ideal solution for offering single-tier and double-tier compartments in the same locker! **Combination lockers, single-tier and double-tier; single-tier:** 1 door, coat rail, and 3 sliding hooks per compartment; **double-tier:** 2 compartments on top of one another, 1 door, coat rail, and 3 sliding hooks per compartment, doors with turning bolt latch for padlock. For bench slats for models 49650, see left. For general description of the lockers see page 404/405.

Lockers with feet

on feet 150 mm high, depth 500 mm.
Clear opening dimensions per door:
1600/813 x 330 x 465 mm (H x W x D)

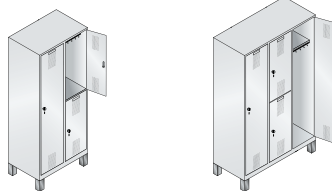

1. Dimensions and door material	Width	800	1200
	Steel doors	Height	1850
	Compartments	2 x 400	3 x 400
	CSC	5	6
	Order no.	49610-22	49610-32
	Price €	449,-	599,-

Lockers with base

on base 100 mm high, depth 500 mm.
Clear opening dimensions per door:
1600/813 x 330 x 465 mm (H x W x D)



1. Dimensions and door material	Width	800	1200
	Steel doors	Height	1800
	Compartments	2 x 400	3 x 400
	CSC	5	6
	Order no.	49620-22	49620-32
	Price €	468,-	621,-

Lockers with bench underneath

Bench height 420 mm, bench depth 315 mm,
locker depth 500/815 mm.
Clear opening dimensions per door:
1600/813 x 330 x 465 mm (H x W x D)

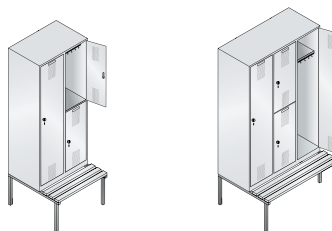

1. Dimensions and door material	Width	800	1200
	Steel doors	Height	2090
	Compartments	2 x 400	3 x 400
	CSC	5	6
	Order no.	49650-22	49650-32
	Price €	669,-	845,-

+ MDF decor doors	Thickness 18 mm		
	+ Order no.	+ 49622-750	+ 49632-750
	+ Addtl. charge €	+ 120,-	+ 170,-
+ HPL decor doors	Thickness 13 mm		
	+ Order no.	+ 49622-730	+ 49632-730
	+ Addtl. charge €	+ 180,-	+ 260,-

+ Accessories	Additional fittings, locks	429	- 435
---------------	----------------------------------	-----	-------



Order no. 49610-22



Order no. 49620-32

Assembled box lockers



Doors single-walled smooth, without rosette hole patterns and without label holders (if required please order additional plastic label holders, order no. 8500-15, page 399). Every door with cylinder lock and 2 keys. The bottoms of the compartments are generally finished in the color of the body. Decor doors in birch, cherry, or wenge decor with black edge band, with door opening limiter as standard feature.

Note: For publicly accessible lockers, we recommend door opening limiters, see page 427.

Lockers with 3 tiers

on feet 150 mm high, depth 500 mm.
Clear opening dimensions per compartment:
510 x 230/330 x 465 mm (H x W x D)



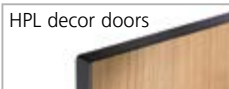

1. Dimensions and door material		Width	300	400	600	800
		Height	1850	1850	1850	1850
		Compartments	1 x 300	1 x 400	2 x 300	2 x 400
	CSC		3	4	5	6
	Order no.		49010-103	49010-123	49010-203	49010-223
	Price €		309,-	344,-	482,-	574,-
	Thickness 18 mm					
		+ Order no.	+ 49310-750	+ 49312-750	+ 49320-750	+ 49322-750
		+ Addtl. charge €	+ 70,-	+ 80,-	+ 140,-	+ 160,-
	Thickness 13 mm					
		+ Order no.	+ 49310-730	+ 49312-730	+ 49320-730	+ 49322-730
		+ Addtl. charge €	+ 90,-	+ 110,-	+ 180,-	+ 220,-

Lockers with 4 tiers

on feet 150 mm high, depth 500 mm.
Clear opening dimensions per compartment:
375 x 230/330 x 465 mm (H x W x D)

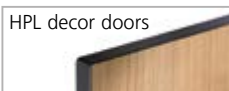

1. Dimensions and door material		Width	300	400	600	800
		Height	1850	1850	1850	1850
		Compartments	1 x 300	1 x 400	2 x 300	2 x 400
	CSC		3	4	5	6
	Order no.		49010-104	49010-124	49010-204	49010-224
	Price €		355,-	389,-	539,-	654,-
	Thickness 18 mm					
		+ Order no.	+ 49410-750	+ 49412-750	+ 49420-750	+ 49422-750
		+ Addtl. charge €	+ 80,-	+ 90,-	+ 160,-	+ 180,-
	Thickness 13 mm					
		+ Order no.	+ 49410-730	+ 49412-730	+ 49420-730	+ 49422-730
		+ Addtl. charge €	+ 100,-	+ 120,-	+ 200,-	+ 240,-

2. **Body color** (see end of catalog for color overview)
 Please choose **587**

3. **Door color** (door decor for MDF or HPL design if applicable)
 Please choose **587**

+ **Accessories**
 Additional fittings, locks **429** - **435**

Assembled box lockers

+ Base
instead of feet, design
in body color, 100 mm
base height, locker
height 1800 mm

Width	300	400	600	800	900	1200
Order no.	49020-...	49020-...	49020-...	49020-...	49020-...	49020-...
+ Addtl. charge €	+ 12,-	+ 14,-	+ 16,-	+ 18,-	+ 18,-	+ 22,-

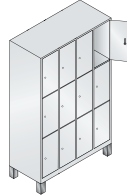
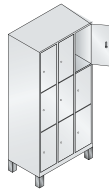

1.	900	1200	1200
	1850	1850	1850
	3 x 300	3 x 400	4 x 300
	6	7	7
	49010-303	49010-323	49010-403
	689,-	799,-	965,-

+	+ 49330-750 + 210,-	+ 49332-750 + 240,-	+ 49340-750 + 280,-
----------	------------------------	------------------------	------------------------

+	+ 49330-730 + 270,-	+ 49332-730 + 330,-	+ 49340-730 + 360,-
----------	------------------------	------------------------	------------------------

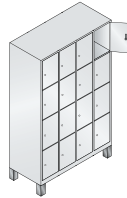
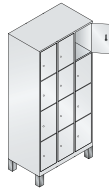

1.	900	1200	1200
	1850	1850	1850
	3 x 300	3 x 400	4 x 300
	6	7	7
	49010-304	49010-324	49010-404
	774,-	933,-	1.029,-

+	+ 49430-750 + 240,-	+ 49432-750 + 270,-	+ 49440-750 + 320,-
----------	------------------------	------------------------	------------------------

+	+ 49430-730 + 300,-	+ 49432-730 + 360,-	+ 49440-730 + 400,-
----------	------------------------	------------------------	------------------------



Optional: **Decor fronts** (MDF)
You can choose from the following
decors (surface "Supermatt"):



Birch



Cherry



Wenge





Lockers with 5 tiers

on feet 150 mm high, depth 500 mm.
Clear opening dimensions per compartment:
295 x 230/330 x 465 mm (H x W x D)

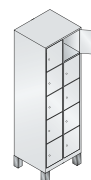
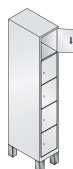

1. Dimensions and door material

Steel doors



	300	400	600	800
Width	300	400	600	800
Height	1850	1850	1850	1850
Compartments	1 x 300	1 x 400	2 x 300	2 x 400
CSC	4	5	6	7
Order no.	49010-105	49010-125	49010-205	49010-225
Price €	399,-	436,-	599,-	718,-

+ MDF decor doors



Thickness 18 mm				
+ Order no.	+ 49510-750	+ 49512-750	+ 49520-750	+ 49522-750
+ Addtl. charge €	+ 90,-	+ 100,-	+ 180,-	+ 200,-

+ HPL decor doors



Thickness 13 mm				
+ Order no.	+ 49510-730	+ 49512-730	+ 49520-730	+ 49522-730
+ Addtl. charge €	+ 110,-	+ 130,-	+ 220,-	+ 260,-

2. Body color (see end of catalog for color overview)



Please choose 587

Assembled box lockers

Doors single-walled smooth, without rosette hole patterns and without label holders (if required please order additional plastic label holders, order no. 8500-15, page 399).

Every door with cylinder lock and 2 keys. The bottoms of the compartments are generally finished in the color of the body. Decor doors in birch, cherry, or wenge decor with black edge band, with door opening limiter as standard feature.

Note:

For publicly accessible lockers, we recommend door opening limiters, see page 427.



Order no. 49010-405
+ 49140-750 (MDF decor doors)

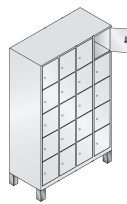
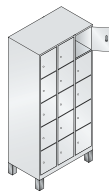

1.	900	1200	1200
	1850	1850	1850
	3 x 300	3 x 400	4 x 300
	7	8	8
	49010-305	49010-325	49010-405
	859,-	1.019,-	1.145,-
+	+ 49530-750	+ 49532-750	+ 49540-750
	+ 270,-	+ 300,-	+ 360,-
+	+ 49530-730	+ 49532-730	+ 49540-730
	+ 330,-	+ 390,-	+ 440,-

+ **Base**
instead of feet,
steel design,
100 mm high



Color (standard)	Locker height	Body color	1800
Order no.	+ Addtl. charge €	49020-...	see page 421

3. **Door color** (door decor for MDF or HPL design if applicable)
 Please choose **587**

+ **Accessories**
Additional fittings, locks **429** - **435**

The open wardrobes offer:

- Durable steel structure
- Steel doors single-walled smooth
- Alternatively: MDF decor doors in birch, cherry, or wenge decor with black edge band
- Plastic label holders optionally available, order no. 8500-15, see page 399
- Each compartment with cylinder lock and 2 keys
- Hat rack and shoe rack in black gray RAL 7021
- The bottoms of the compartments are generally finished in the body color.
- Delivered disassembled with detailed mounting instructions for easy DIY assembly



Order no. 49410-00
+ 4940-20 (base)

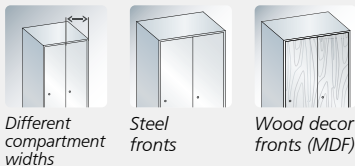

Locker with feet, compartment width 300 mm

On feet 150 mm high, depth 500 mm.
Locker consisting of two assembled box lockers, hat shelf and shoe rack made of square profile in between, with 6, 8, or 10 plastic coat hangers in black

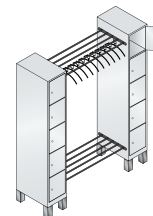
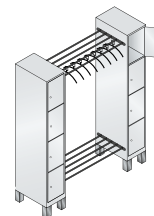
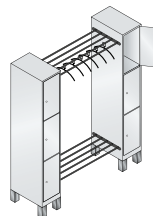

1. Dimensions and door material

	1600	1600	1600
Width	1600	1600	1600
Height	1850	1850	1850
Compartments	2 x 300	2 x 300	2 x 300
Clear opening dimensions per door (H x W x D):	510 x 230 x 465 mm	375 x 230 x 465 mm	295 x 230 x 465 mm
Assembled box lockers	3 compartments models 49010-103	4 compartments models 49010-104	5 compartments models 49010-105
for no. of persons	6	8	10
CSC	6	6	8
Order no.	49406-00	49408-00	49410-00
Price €	749,-	859,-	969,-



+	MDF decor doors	Thickness 18 mm			
		+ Order no.	+ 494060-750	+ 494080-750	+ 494100-750
		+ Addtl. charge €	+ 140,-	+ 160,-	+ 180,-
+	HPL decor doors	Thickness 13 mm			
		+ Order no.	+ 494060-730	+ 494080-730	+ 494100-730
		+ Addtl. charge €	+ 180,-	+ 200,-	+ 220,-

2. Body color (see end of catalog for color overview)



Please choose 587

- + **Base**
instead of feet,
steel design,
100 mm high



Color (standard)	Body color
Locker height	1800
Order no.	4940-20
+ Addtl. charge €	+ 24,-

- + **Special coat hangers**
in black, bulk

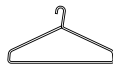

Design	plastic
+ Order no.	+ 8078-703
+ Addtl. charge €	+ 11,-



Order no. 49410-02
+ 494102-750 (MDF decor doors)

Locker with feet, compartment width 400 mm

On feet 150 mm high, depth 500 mm.
Locker consisting of two assembled box lockers,
hat shelf and shoe rack made of square profile
in between, with 6, 8, or 10 plastic
coat hangers in black

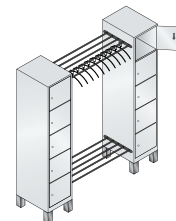
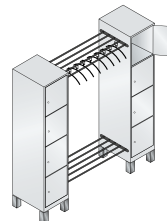
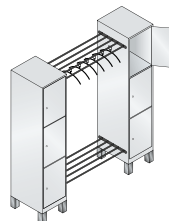

1. Dimensions and door material

	1800	1800	1800
Width	1800	1800	1800
Height	1850	1850	1850
Compartments	2 x 400	2 x 400	2 x 400
Clear opening dimensions per door (H x W x D):	510 x 330 x 465 mm	375 x 330 x 465 mm	295 x 330 x 465 mm
Assembled box lockers for no. of persons	3 compartments models 49010-123 6	4 compartments models 49010-124 8	5 compartments models 49010-125 10
Steel doors	CSC 8 Order no. 49406-02 Price € 819,-	CSC 8 Order no. 49408-02 Price € 927,-	CSC 10 Order no. 49410-02 Price € 1.043,-

+ MDF decor doors



Thickness 18 mm			
+ Order no.	+ 494062-750	+ 494082-750	+ 494102-750
+ Addtl. charge €	+ 160,-	+ 180,-	+ 200,-

+ HPL decor doors

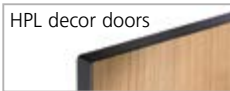

Thickness 13 mm			
+ Order no.	+ 494062-730	+ 494082-730	+ 494102-730
+ Addtl. charge €	+ 220,-	+ 240,-	+ 260,-

3. Door color (door decor for MDF or HPL design if applicable)



Please choose 587

Top lockers

Doors single-walled smooth, without rosette hole patterns and without label holders (if required please order additional plastic label holders, order no. 8500-15, page 399).

Compartment width of 400 mm also suitable for motorcycle helmets.

Doors with turning bolt latches.



Turning bolt latch standard with door protection



Order no. 49090-30 (top cabinet)



Order no. 49092-20 (top cabinet)

Top lockers

Depth 500 mm. Clear opening dimensions per door: 430 x 230/330 x 465 mm (H x W x D)

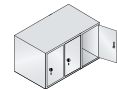

1. Dimensions and door material



Steel doors

Width	300	400	600	800	900	1200
Height	500	500	500	500	500	500
Compartments	1 x 300	1 x 400	2 x 300	2 x 400	3 x 300	3 x 400
CSC	1	1	2	2	3	3
Order no.	49090-10	49090-12	49090-20	49090-22	49090-30	49090-32
Price €	169,-	183,-	249,-	275,-	344,-	378,-

+ MDF decor doors



Thickness 18 mm						
+ Order no.	+ 490910-750	+ 490912-750	+ 490920-750	+ 490922-750	+ 490930-750	+ 490932-750
+ Addtl. charge €	+ 23,-	+ 27,-	+ 46,-	+ 54,-	+ 69,-	+ 81,-

+ HPL decor doors



Thickness 13 mm						
+ Order no.	+ 490910-730	+ 490912-730	+ 490920-730	+ 490922-730	+ 490930-730	+ 490932-730
+ Addtl. charge €	+ 30,-	+ 37,-	+ 60,-	+ 74,-	+ 90,-	+ 111,-

Top lockers

with doors closing in the middle, depth 500 mm. Clear opening dimensions per door: 430 x 230/330 x 465 mm (H x W x D)

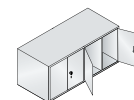

1. Dimensions and door material



Steel doors

Width	600	800	1200	1600
Height	500	500	500	500
Compartments	2 x 300	2 x 400	4 x 300	4 x 400
CSC	2	2	4	4
Order no.	49092-20	49092-22	49092-40	49092-42
Price €	249,-	275,-	409,-	469,-

2. Body color (see end of catalog for color overview)



Please choose

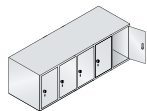
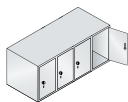

1.	1200	1600	1500
	500	500	500
	4 x 300	4 x 400	5 x 300
	4	4	4
	49090-40	49090-42	49090-50
	409,-	469,-	489,-
+	+ 490940-750	+ 490942-750	+ 490950-750
	+ 92,-	+ 108,-	+ 115,-
+	+ 490940-730	+ 490942-730	+ 490950-730
	+ 120,-	+ 148,-	+ 150,-

+ **New door opening limiter 90°**
 made from special heavy-duty, plastic-coated stainless steel cable



Design	Price per door
+ Order no.	4900-700
+ Addtl. charge €	+ 11,-

Without door opening limiter

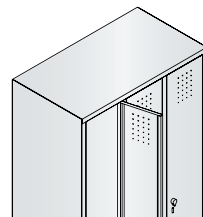

110°

- + For specifically assigned compartments
- + More freedom of movement for users
- Forceful over-extension of the door by opening it too far is possible
- Damage to usable space of adjacent locker is possible

With door opening limiter 90°

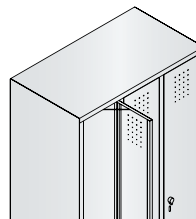

90°

- + Recommended if lockers are frequently used by different persons
- + Prevents forceful over-extension of the door by opening it too far
- + No overlap with usable space of adjacent locker
- Less freedom of movement for users
- Cannot be used at emergency exits

NEW

3. Door color (door decor for MDF or HPL design if applicable)



Please choose

S 3000 *Erolo*

Laundry collecting and dispensing lockers

+ Laundry bags
made of 100% polyester,
with 4 hanging loops,
Packaging unit:
5 pieces



Design	White
+ Order no.	48270-7015
+ Addtl. charge €	+ 239,-



Order no. 48060-205



Order no. 48170-210

Lockers with feet

on feet 150 mm high, depth 500 mm

Attention! Locker with integrated slope (order no. 8000-38) not possible

1. Dimensions and design

Width	420	420	810	810	420
Height	1850	1850	1850	1850	1850
Doors	5	10	10	20	1
Clear opening dimensions H x W x D	per door 269 x 251 x 475	per door 126 x 251 x 475	per door 269 x 295 x 475	per door 126 x 295 x 475	per swing flap 282 x 270 x 475

Description

Laundry dispensing lockers
with central door by which the entire column of compartments can be opened at once (e.g. for loading). Compartments and central doors with cylinder lock and 2 keys, longer delivery time

Laundry collecting lockers
one swing flap at the top in the hinged door, hinged door with cylinder lock and 2 keys. Laundry bag retaining hooks inside



Steel doors	CSC	6	7	8	8	6
	Order no.	48060-105	48060-110	48060-205	48060-210	48070-210
	Price €	589,-	989,-	1.079,-	1.479,-	389,-

Lockers with base

on base 100 mm high, depth 500 mm

Attention! Locker with integrated slope (order no. 8000-38) not possible

1. Dimensions and design

Width	420	420	810	810	420
Height	1800	1800	1800	1800	1800
Doors	5	10	10	20	1
Clear opening dimensions H x W x D	per door 269 x 251 x 475	per door 126 x 251 x 475	per door 269 x 295 x 475	per door 126 x 295 x 475	per swing flap 282 x 270 x 475

Description

see above

see above



Steel doors	CSC	6	7	8	8	6
	Order no.	48160-105	48160-110	48160-205	48160-210	48170-210
	Price €	599,-	999,-	1.099,-	1.499,-	399,-

2. Body and door color (see end of catalog for color overview)

Please choose 587

+ Accessories

Additional fittings, locks 429 - 435

The S 3000 Evolo accessory range offers:

The difference lies in the details! C+P offers a multitude of practical additional fittings and upgrading components. For you this means:

- All requirements can be met for a customized result
- Lockers "made-to-order" for the specific location
- All parts can be ordered separately (no additional charge packages, you only pay for what you need!)
- Many parts can also be retrofitted
- Excellent price-performance ratio thanks to C+P modular system

Wet room design*

electrolytically galvanized, enamel coated, compartment widths 300 and 400 mm, additional charge per compartment width

see also page 376

for lockers with	feet or base	bench
Order no.	8000-20	8000-21
+ Addtl. charge €	+ 27,-	+ 39,-



Order no. 49050-40
with additional fittings:
1 x 8000-7035 (plastic bench slats)
1 x 8504-40 (slope top)
4 x 8000-21 (electrolytically zinc-plated design)

Top locker bag unit

approx. 200 mm high for retrofitting, black gray color, made of MCPB material



Compartment width	300/400	300/400	300/400	300
Depth	500	500	500	500
for number of compartments	2	3	4	5
Order no.	8505-20/22	8505-30/32	8505-40/42	8505-50
+ Addtl. charge €	+ 139,-	+ 159,-	+ 179,-	+ 199,-

Slanted roof designs

Depth 500 mm

Slope top
approx. 230 mm higher in the back for retroactive fitting

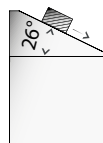

Slope top
Can be retrofitted later, prevents objects from being left on top



Compartment width	300/400	300/400	300/400	300/400	300
for number of compartments	1	2	3	4	5
CSC	1	1	1	2	2
Order no.	4931/41-70	4932/42-70	4933/43-70	4934/44-70	4935-70
+ Addtl. charge €	+ 60,-	+ 72,-	+ 84,-	+ 96,-	+ 108,-

Door designs

Additional charge per door

Doors smooth

without louvers, without label holders (ensure alternative ventilation e.g. through rosette hole patterns!)



Order no.	8001-303
+ Addtl. charge €	+ 0,-

Door with perforated panel

for models 49010-49090, compartment width 300/400 mm (square perforations approx. 23 mm with bars approx. 5 mm), 3-bolt latch recommended



Order no.	8001-323
+ Addtl. charge €	+ 14,-

* longer delivery time possible

Partitions

below the hat shelf,
additional charge per
compartment

made of steel
in swivel design,
cannot be retrofitted



Partition H x W
Order no.
+ Addtl. charge €

1000 x 460
0080-00
+ 40,-

made of steel
in fixed design,
cannot be retrofitted



1280 x 420
0090-00
+ 40,-

made of transparent plastic,
movable and swivel design,
low-maintenance



1210 x 300
4500-705
+ 45,-

**made of blue
linen material**
movable and swivel design,
with several pockets



1170 x 450
4500-706
+ 30,-

Additional fittings

Slot-in shoe shelf
Steel, black gray coating,
can be easily retrofitted
by users
(installation height 250 mm)



Compartment width
Order no.
Price €

300	400
4900-765	4900-766
24,-	25,-

Security compartment inside*
(instead of the hat shelf)
with cylinder lock,
not possible for
order no. 8000-38



300/400
8053-00
70,-

Mirror
to be mounted by the
customer, price per door



small, W x H 110 x 90 mm	large, W x H 180 x 300 mm
-	-
4500-761	4500-762
5,-	12,-

Standard coat hanger
Hardwood varnished
in black (with special
mounting)



-
8000-061
5,50

Additional fittings

Prices per door

Towel holder
for mounting on doors hinged
on the right

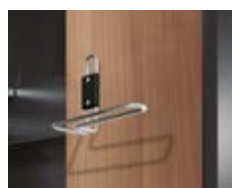

Design for
Compartment width
Order no.
Price €

Steel doors	Decor doors
300	300/400
4900-770	4900-7703
13,-	13,-

Towel and shower gel holder
for mounting on doors hinged
on the right



Steel doors	Decor doors
400	300/400
4900-772	4900-7723
21,-	21,-

Flip-flop and shoe holder
(not suitable for lockers with storage
box or partitions)



Steel doors	Decor doors	
300	400	300/400
4900-773	4900-7732	4900-7733
21,-	21,-	21,-

Additional fittings

Prices per door

**Door opening
limiter 90°**
addtl. charge for **steel**
doors, for user instruc-
tions see page 427



Compartment width
Order no.
Price €

-
4900-700
11,-

**Double
sliding hooks**
as replacement,
per piece



-
8500-012
0,60

Shoe rack
for models with bench **built
underneath**, retrofitting possible
since May 1st 2012, addtl. charge
per compartment



300	400
8050-7010	8052-7010
35,-	40,-

Shoe rack
for models with bench **in front**,
retrofitting possible since
May 1st 2012, addtl. charge
per compartment



300	400
8030-701	8032-701
35,-	40,-

Additional accessories

Padlocks

for turning bolts and safety turning bolts, bolt size approx. 6 mm

Brass design, 2 keys, up to 300 different key numbers

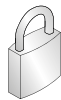

Order no. **0002-10**
Price € 8,50

Brand lock in brass design with precision cylinder, 2 keys, up to 168,000 different key numbers

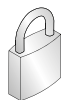

Order no. **0002-11**
Price € 23,-

High-gloss chrome-plated with number combination, without keys



Order no. **0002-12**
Price € 45,-



Play it safe – with the new standard C+P safety turning bolt



The problem

Conventional turning bolt latches are highly susceptible to break-ins because the latch can be overwound.

The burglar uses the padlock as a lever (the longer the shackle, the greater the leverage). Overwinding destroys the locking mechanism and opens the way to the locker compartment.







The C+P solution

The C+P safety turning bolt cannot be overwound because it "spins" when it is closed, thus preventing tampering!



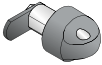

The cylinder lock engages only when the padlock is removed, and the door can be opened simply by turning the knob. For lock bolt size 6-8 mm.

Accessories for lockers

Turning bolt latch and cylinder locks not for assembled box lockers

Prices per lock	Basic design		Optional					
	Turning bolt latch	Cylinder lock in black with 2 keys		Lock in moisture-proof design cylinder lock in black				
								
	for padlock incl. lock guard	up to 1000 different key numbers	up to 6000 different key numbers	via master key system with security certificate*	via master key system without security certificate*	up to 1000 different key numbers	via master key system with security certificate*	via master key system without security certificate*
Order no.	4800-718	0008-70	0008-700	0010-10	0010-010	0008-72	0010-12	0010-012
Unit price €	6,-	11,-	16,-	39,-	18,-	14,-	42,-	21,-
+ Addtl. charge €	Standard	+ 5,-	+ 10,-	+ 33,-	+ 12,-	+ 8,-	+ 36,-	+ 15,-

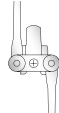
Keys, locks, and wristband for cylinder locks

	Spare keys for cylinder lock		Master key for master key system		3-bolt latch**	Perlon wristband for cylinder locks
						
	Spare key for lock 0008-70	Spare key for lock 0008-700	with security certificate*	without security certificate*	with locking rods	Please indicate numbering from-to and list desired color no. ¹⁾
Order no.	0006-21	0006-00	0011-00	0012-00	8000-23	8501-05..
Price €	12,-	13,50	16,50	11,50	24,-	10,-

- ¹⁾ 51 black 56 gray
 52 white 61 green
 53 red 67 yellow
 55 blue 73 orange

Locking no. according to customer requirements	for cylinder lock (longer delivery time)
Additional charge per lock	
Order no.-..99
+ Addtl. charge €	+ 8,-

Additional accessories for all lockers

Door protection and numbering



Design
Order no.
Price €

Door protection
also suitable for holding number plate model 4400-744. Only possible with cylinder lock models 0008-70, 0008-700, 0010-10, 0010-010



plastic
4500-742
3,-

Number plate for easy DIY attachment above the door protection (please specify desired 3-digit numbering!), to be used only in conjunction with door protection, not suitable for coin-operated deposit locks



plastic
4500-744
1,50









SAFE-O-MAT locks **459** + **513**









Coin-operated deposit lock **459**

Accessories for assembled box lockers

Turning bolt latch and cylinder locks only for assembled box lockers

Prices per lock	Basic design				Optional			
	Cylinder lock	Cylinder lock in black with 2 keys		Lock in moisture-proof design cylinder lock in black	Turning bolt latch			
								
	up to 1000 different key numbers	up to 6000 different key numbers	via master key system with security certificate*	via master key system without security certificate*	up to 1000 different key numbers	via master key system with security certificate*	via master key system without security certificate*	for padlock incl. lock guard
Order no.	0008-70	0008-700	0010-10	0010-010	0008-72	0010-12	0010-012	4500-718
Unit price €	11,-	16,-	39,-	18,-	14,-	42,-	21,-	6,-
+ Addtl. charge €	Standard	+ 5,-	+ 28,-	+ 7,-	+ 3,-	+ 31,-	+ 10,-	- 5,-

Keys and wristband for cylinder locks

	Spare keys for cylinder lock		Spare key for master key system		Master key for master key system		Perlon wristband for cylinder locks
							
	Spare key for lock 0008-70	Spare key for lock 0008-700	with security certificate*	without security certificate*	with security certificate*	without security certificate*	Please indicate numbering from-to and list desired color no. ¹⁾
Order no.	0006-21	0006-00	0010-11	0006-00	0011-00	0012-00	8501-05..
Price €	12,-	13,50	25,-	13,50	16,50	11,50	10,-

¹⁾ 51 black 56 gray
 52 white 61 green
 53 red 67 yellow
 55 blue 73 orange

Additional accessories for all lockers

Key ring

Plastic key ring
with S-hook, Ø 30 mm, please indicate numbering

Optional integrated numbering
thanks to self-adhesive film in the embossed label holder (please specify from-to numbering and indicate color²⁾)

Locker numbering
for **decor** doors (MDF and HPL), please specify from-to numbering and color³⁾

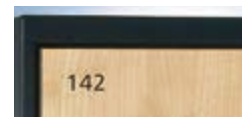

Design	black	white	aluminum color	self-adhesive	self-adhesive
Order no.	8502-0851	8502-0852	8502-0862	4900-701..	4900-749..
Price €	4,-	4,-	4,-	4,-	4,-

Number plates

Number plates
in lock area, self-adhesive

Stainless steel number plate
self-adhesive, 30 x 50 x 1.0 mm

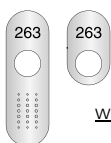

with integrated door protection
123 x 39 x 1.0 mm

without integrated door protection
68 x 39 x 1.0 mm

263

Design	plastic	Stainless steel	plastic	Stainless steel	Stainless steel
Order no.	4902-0601	4901-0601	4902-0611	4901-0611	8501-06
Price €	6,-	14,-	4,-	12,-	13,-

²⁾ 51 black
56 light gray
65 white aluminum

³⁾ 51 black
65 white aluminum

Mirror face plates

Evo offers a range of different end solutions to enhance both the function and the appearance of the ends of rows of lockers, which often go unused.

The panels with integrated mirrors with or without deposit areas, with sockets or lighting, allow for customized options for this space.

They can either be attached to lockers or simply to the walls of a room.



End face plate

to be attached to the side of the locker row, for locker depths of 500 mm

Locker configuration
single-row

Locker configuration
back to back

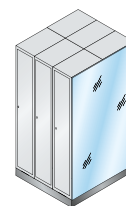
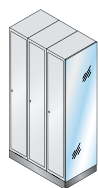

Width
Height

500
1700

1000
1700

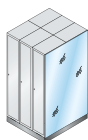

Mirror full surface

Order no.
Price €

4010-170050
399,-

4010-170100
599,-

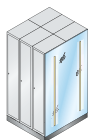

Mirror full surface and 2 LED lights behind the mirror

Order no.
Price €

-
-

4011-170100
1.590,-

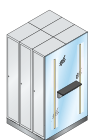

Mirror full surface, deposit area with 2 sockets, 2 LED lights behind the mirror

Order no.
Price €

-
-

4012-170100
2.090,-

Face plates

These panels are not suitable for lockers with bases.
We recommend taking the measurements after the lockers have been delivered and assembled.

Front face plates

made of steel, coated in color of front

Adjustable steel panels, without shadow gap

Gap width	30-45	40-55	50-65	60-75	70-85	80-95	90-105	100-115
Order no.	4001-170003	4001-170004	4001-170005	4001-170006	4001-170007	4001-170008	4001-170009	4001-170010
Price €	60,-	63,-	64,-	67,-	68,-	70,-	71,-	73,-

Steel panels not adjustable (fixed dimensions), with 10 mm shadow gap right and left

Gap width	110	145	180	215	250
Order no.	4002-170011	4002-170014	4002-170018	4002-170021	4002-170025
Price €	82,-	84,-	89,-	93,-	96,-

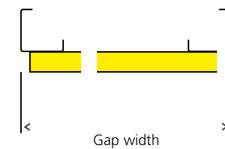
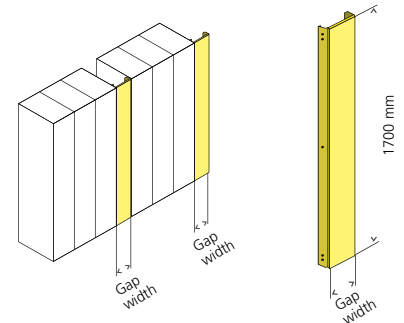

Interior corner face plates

made of steel, coated in color of front

Steel panels for 90° interior corners, not adjustable (fixed dimensions), with 10 mm shadow gap right and left

Gap width	110	145	180	215	250
Distance to wall	579	604	629	653	678
Order no.	4004-170011	4004-170014	4004-170018	4004-170021	4004-170025
Price €	82,-	84,-	89,-	93,-	96,-

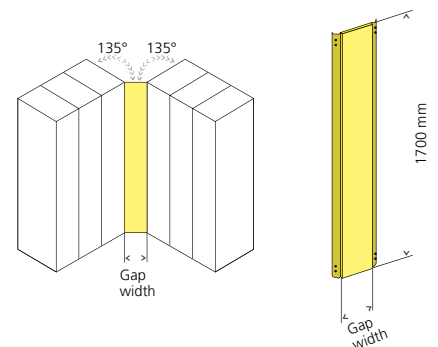

Exterior corner face plates

made of steel, coated in color of front

Steel panels for 90° exterior corners, not adjustable (fixed dimensions), with 10 mm shadow gap right and left

for locker depth	500
Order no.	4003-170050
Price €	113,-

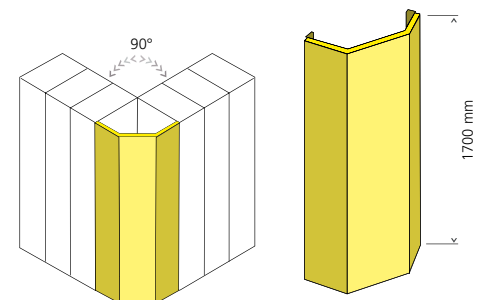
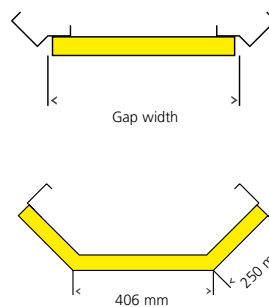

Positions of face plates in the space plan

